

Varenummer: 03445030
Beskrivelse: Fluro Heavy Duty Ledleje GE 30 EW-2RS
Hul Ø30
Note: 30

Mål

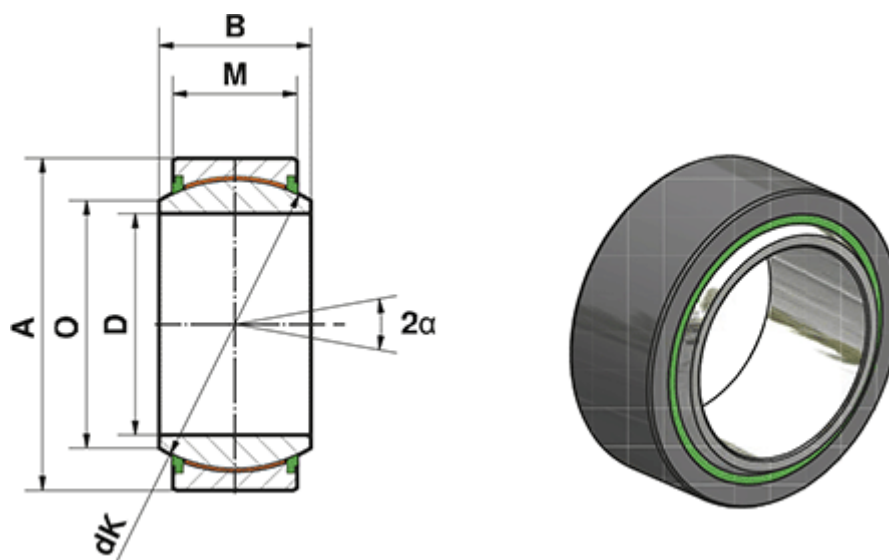

A	= 47	Statisk belastning C0 (kN) = 275
a (grader)	= 6	Vægt (g) = 140
B	= 22	
D	= 30	
dK	= 40.7	
Dynamisk belastning C (kN)	= 165	
M	= 18	
O	= 34.2	